



Desktop Sneeze Guards (DSG)

Instant Assembly, No Hardware Required

Desktop sneeze guards assemble in seconds, sliding into included bases with no hardware required. They can be used on any countertop, are easy to clean, and portable. Desktop sneeze guards come with a built-in 18" wide pass-through slot at the bottom to allow documents or wires through while remaining effective as a physical barrier. Rounded corners for added safety. Custom sizes available.

HEIGHT:
23.5"
WIDTH OPTIONS:
31.5, 35.5"
MATERIAL THICKNESS:
1/4", 3/8"

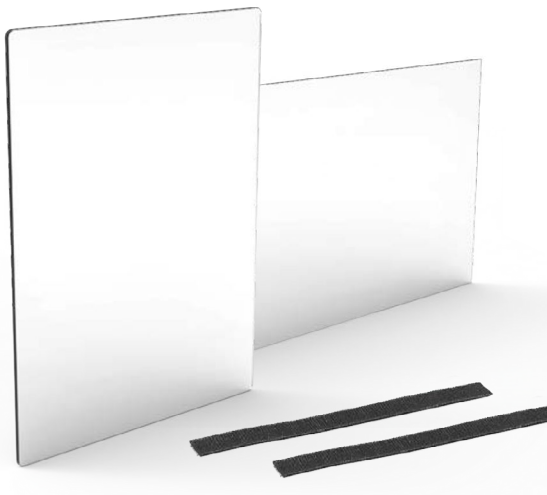
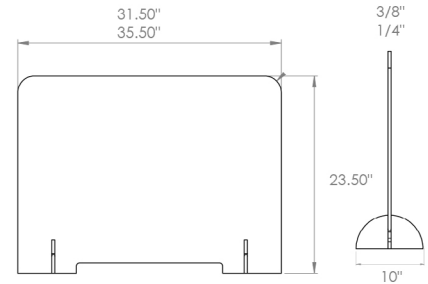

Velcro-Mounted Sneeze Guards (VMMSG)

Easy-to-Mount, Rounded Corners for Added Safety

Velcro-mounted sneeze guards are transparent clear sheets with rounded corners that can be installed against any flat surface using the included Velcro strips. Perfect for checkout registers, pharmacies, banks and other point-of-purchase areas by acting as a physical barrier to help prevent the spread of germs. These sneeze guards can be easily sanitized using non-abrasive cleaners.

HEIGHT OPTIONS:
18", 24", 30", 32", 38", 48", 72", 96"
WIDTH OPTIONS:
18", 24", 30", 32", 38", 48", 72", 96"
MATERIAL THICKNESS:
1/8", 1/4"

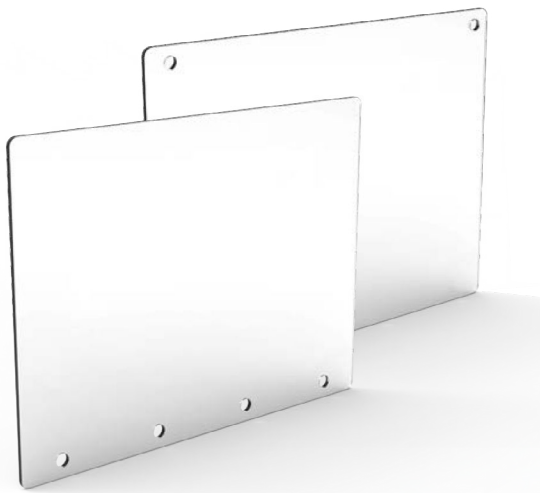
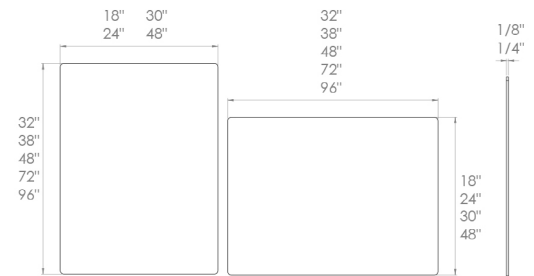

Bolt-Mounted & Hanging Sneeze Guards (BMSG & HSG)

Rounded Corners, Pre-Drilled Holes for Mounting/Hanging

These clear sheets with rounded corners come pre-drilled with two or four holes for mounting or hanging. Mounted sneeze guards are more securely connected and can handle more impact. Hanging sneeze guards are ideal for use when additional space is needed to regularly pass larger items or packages through the bottom of the guard — common in pharmacies, distribution centers, and post offices.

HEIGHT OPTIONS:
18", 24", 36", 48"
WIDTH OPTIONS:
24", 48", 72", 96"
MATERIAL THICKNESS:
1/8", 1/4"
PRE-DRILLED HOLES:
2 or 4

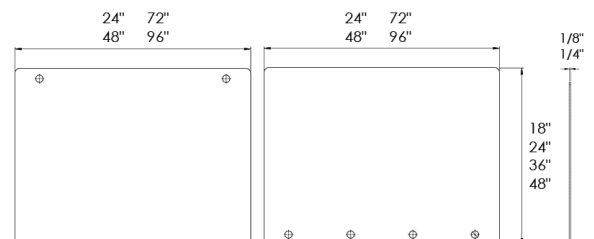

Note: Fasteners sold separately



Vertical Sneeze Guards (VRS)

Pass-through Size Options, Instant Assembly

Vertical sneeze guards act as a barrier to help impede airborne bacteria and viruses. They come with rounded corners for added safety, and two removable base stands for easy assembly and storage. A built-in pass-through slot at the bottom allows documents, small objects, or wires to easily slip under the guard. The pass-through slot is available in sizes 8" x 8" or 10" x 8", with custom sizes available.

HEIGHT:
35.5"
WIDTH OPTIONS:
23.5", 31.5, 35.5"
MATERIAL THICKNESS:
1/4"

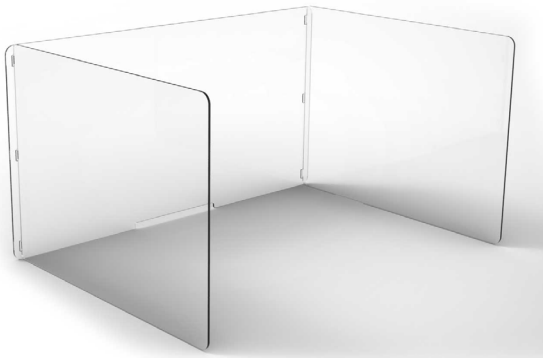
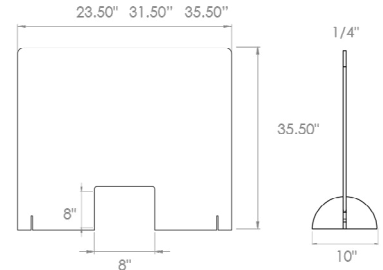

Portable Office Partitions (POP)

U-Shaped Office Desk Partitions for Creating Protected Workspaces

Designed to create protected workspaces in an office environment, portable office partitions act as a physical barrier that surrounds desks, conference tables, or other working spaces. Rounded corners for added safety. Portable office partitions include 3 sheets that interlock at the edges to create a 'U' shaped barrier. A 12" wide pass-through slot at the bottom allows documents and wires through. The partition can be disassembled for transport.

FRONT DIMENSIONS:
48" Wide x 23.5" Tall
SIDE DIMENSIONS:
30" Wide x 23.5" Tall
MATERIAL THICKNESS:
1/4", 3/8"

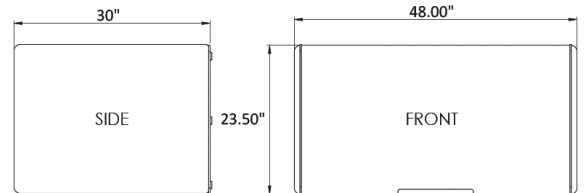

Portable Manicure Station Sneeze Guards (PMNS)

Portable Salon Guard with a Wide Pass-through for Manicures and Pedicures

Portable manicure table sneeze guards allow a greater range of hand movement and protection during cosmetic beauty treatments such as manicures or pedicures. With a 6" tall x 18" wide pass-through slot, the manicure table sneeze guard provides extra comfort for clients while allowing a larger range of hand and arm movement for manicurists and nail technicians. Rounded corners for added safety.

HEIGHT:
23.5"
WIDTH:
31.5"
MATERIAL THICKNESS:
1/4"

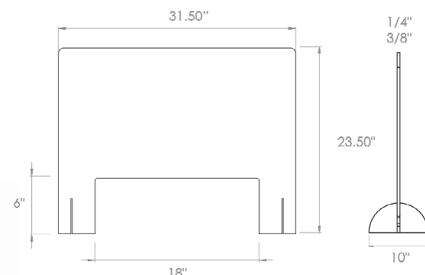

Office & Cafeteria Portable Table Dividers (PTD)

Modular Interlocking Clear Dividers Provide Solutions for any Tabletop

Adding a portable table divider is a proactive way to further protect your employees and customers in break rooms, cafeterias, restaurants, commons, and other public areas. Our portable table dividers ship flat and slide together for instant assembly with no hardware required.

Our table dividers can be used on any countertop, are easy-to-clean, and portable. We offer dividers for circular and rectangular tables in a variety of sizes. Rounded corners for added safety. Custom sizes available upon request.

- Assembles in Seconds
- Lightweight and Portable
- Easy-to-Clean and Disinfect
- Works Great for both Circular and Rectangular Tables

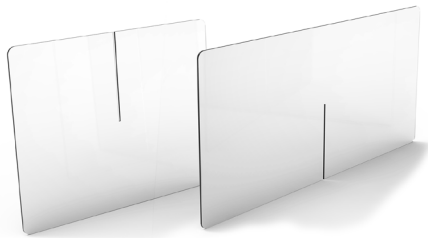
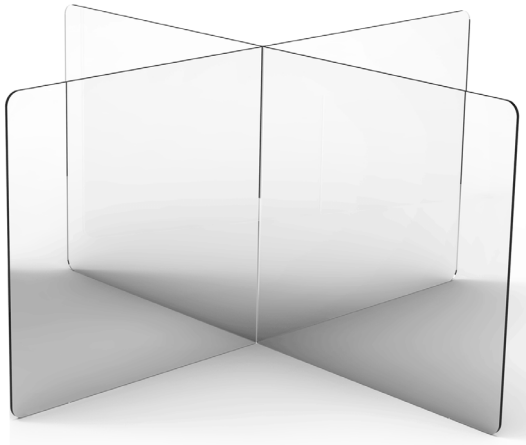

HEIGHT:	23.5"
WIDTH OPTIONS:	30", 47.5", 71.5", 95.5"
MATERIAL THICKNESS:	1/4"

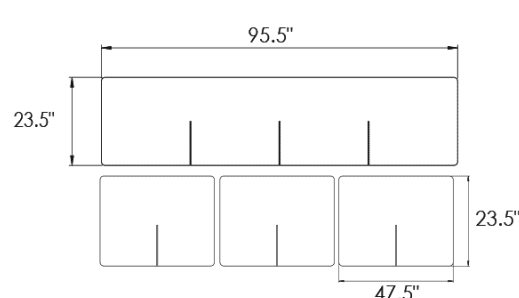
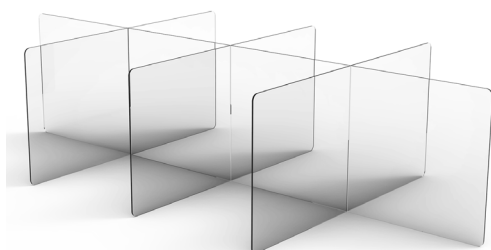
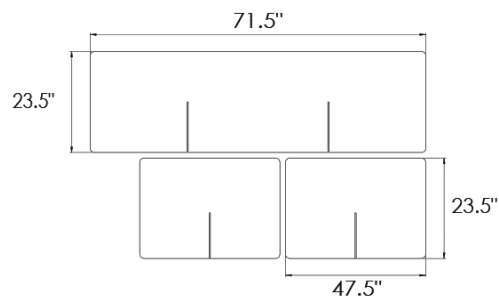
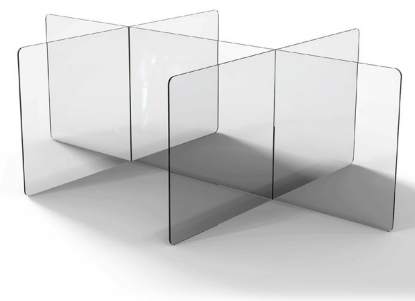
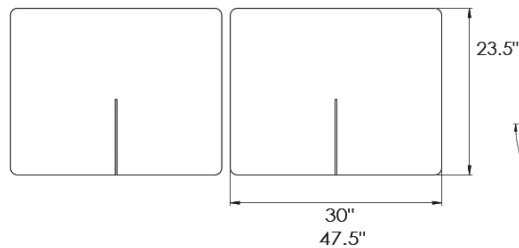
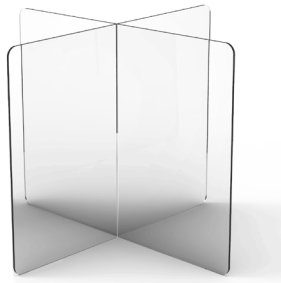
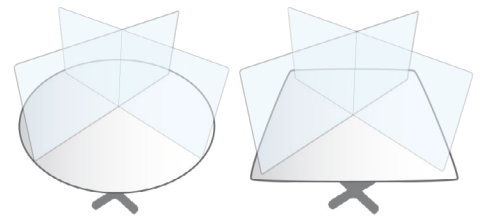

Portable Office Barriers (POB)

Free-standing Office Barriers with Base Mounts

Portable office barriers are free-standing sheets for office and retail environments that act as portable sneeze guards to protect employees and customers — in both large and small spaces. Office barriers come with metal base mounts that allow the barrier to stand upright without additional hardware. Barriers are available in clear and opal translucent polycarbonate twinwall, opaque white and black expanded PVC, and clear acrylic. Rounded corners for added safety.



HEIGHT OPTIONS:
72", 96"
WIDTH OPTIONS:
32", 36", 38"
MATERIAL THICKNESS:
9.53mm (3/8"/.375"), 12mm (.472"), 16mm (.63"),
MATERIAL OPTIONS:
Acrylic, Polycarbonate Twinwall, Foam PVC

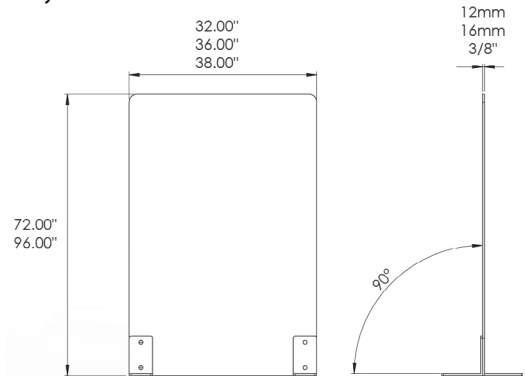

Urinal Partition Extensions (URPE)

Mountable Dividers for Extending Urinal Partitions

These extensions have a 90° angled 2" wide mounting face, making it easy to raise urinal partitions. Urinal partition extensions come with 4 pre-drilled holes for convenient mounting on walls and existing partitions: 2 along the bottom of the sheet, and 2 along the mounting face. A Velcro strip is also included for areas where hardware cannot be used. They can be easily sanitized using non-abrasive cleaners. Rounded corners for added safety. Custom sizes are available.



DIMENSIONS:
22" Wide x 24" Tall
MATERIAL THICKNESS:
1/8"

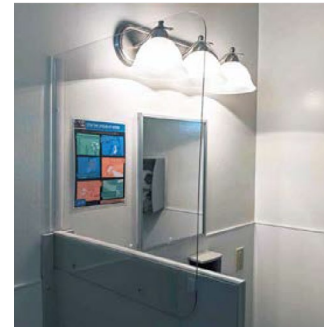

Hospital Face Shields (FSH)

American-Made Face Protection for Use in Hospitals

These comfortable face protection masks feature a 9" tall x 11.75" wide piece of flexible plastic that surrounds the face to help protect from airborne threats, as well as a foam headband to provide a comfortable distance between the face and shield. The attached elastic band keeps these protective masks securely in place. They are already in use by medical professionals.

- Bulk discounts available
- 9" tall x 11.75" wide flexible plastic piece
- Secure elastic band keeps mask in place
- Foam headband creates a comfortable distance between the shield and face

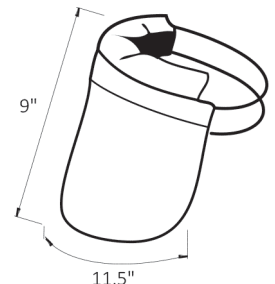

Sunoptics® Personal Protection Barriers (PPB)



Aerosol-Blocking Intubation Shields (ARBIS)

Easy and Safe Access to Patients, Stacks for Easy Shipping

PRE-ASSEMBLED:

Pre-assembled aerosol-blocking shields are ready to deploy without assembly. Order all three sizes for optimal stacked shipping. These shields allow doctors safe access to patient airways while minimizing the risk of airborne virus transmission. Two 4.75" holes allow the unrestricted use of arms during the tracheal intubation process and protect doctors from potential exposure to dangerous aerosols. It is recommended for use whether or not PAPRs are available to maximize protection for healthcare providers during tracheal intubation and tracheotomies.

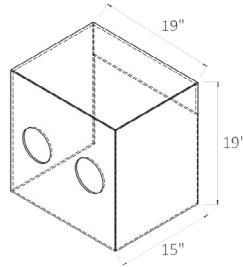

SMALL

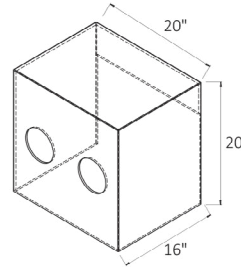

MEDIUM

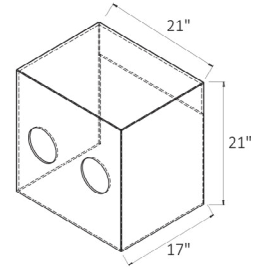

LARGE

Accessories



Brillianze Plastic Cleaner (PLACLN)

Plastic-Safe Cleaner for Your PPB Product

To maintain the optical clarity of sneeze guards and other acrylic or polycarbonate product.

- Available in 8oz or 32oz Spray Bottles
- Use with Microfiber Towel

Microfiber Towels (MFT)

12" x 12" Five-Pack